



SAPIENZA  
UNIVERSITÀ DI ROMA

# Introduction to wireless systems

Internet of Things (ex Advanced Topics in Networking)

a.a. 2015/2016

Un. of Rome "La Sapienza"

Lesson 2

Chiara Petrioli<sup>†</sup>

<sup>†</sup> *Department of Computer Science – University of Rome "Sapienza" – Italy*



SAPIENZA  
UNIVERSITÀ DI ROMA



***Techniques for energy efficient  
communications***





- Portable devices rely on external sources of energy (batteries, solar cells) to be able to communicate
- Battery lifetime is limited
  - Demanding to recharge battery operated devices after some time for the device to remain operational;
- Despite improvements in battery technologies the problem has not been solved (and is not expected to be solved by better battery technology only):
  - energy demand is increasing;
  - users expectations in terms of device/network lifetime are increasing;
- Energy efficient techniques have been developed
- Energy consumption is a critical metric driving wireless systems design



- Portable devices rely on external sources of energy (batteries, solar cells) to be able to communicate
- Battery lifetime is limited
  - Demanding to recharge battery operated devices after some time for the device to remain operational (finite recharging cycles);
- Despite improvements in battery technologies the problem has not been solved (and is not expected to be solved by better battery technology only):
  - energy demand is increasing;
  - users expectations in terms of device/network lifetime are increasing;

### **Network lifetime:**

- Time till the first node in the network dies having depleted its battery;
- Time before the network gets disconnected or fails to perform critical tasks (e.g., coverage of an Area of Interest)



- Portable devices rely on external sources of energy (batteries, solar cells) to be able to communicate
- Battery lifetime is limited
  - Demanding to recharge battery operated devices after some time for the device to remain operational (finite recharging cycles);
- Despite improvements in battery technologies the problem has not been solved (and is not expected to be solved by better battery technology only):
  - energy demand is increasing;
  - users expectations in terms of device/network lifetime are increasing;
- Energy efficient techniques have been developed
- Energy consumption is a critical metric driving wireless systems design





- Portable devices rely on external sources of energy (batteries, solar cells) to be able to communicate

### **Energy efficiency:**

- Expresses how efficiently given tasks are performed.
  - Energy-efficient communication: energy spent by the network per bit correctly delivered to the final destination;
- To be considered in combination with other E2E metrics (throughput/latency)
  - Energy efficient techniques have been developed
  - Energy consumption is a critical metric driving wireless systems design



- Laptop most energy consuming components include CPU, liquid crystal display (LCD) and **wireless network interface card**
  - Toshiba 410 CDT (2001): 36% of energy consumption due to display, 21% due to CPU+memory, 18% due to wireless network interface card
- **Around mid nineties the area of energy efficient communication moved its first steps...**



- Laptop most energy consuming components include CPU, liquid crystal display (LCD) and **wireless network interface card**
  - Toshiba 410 CDT (2001): 36% of energy consumption due to display, 21% due to CPU+memory, 18% due to wireless network interface card
- **Around mid nineties the area of energy efficient communication moved its first steps...**

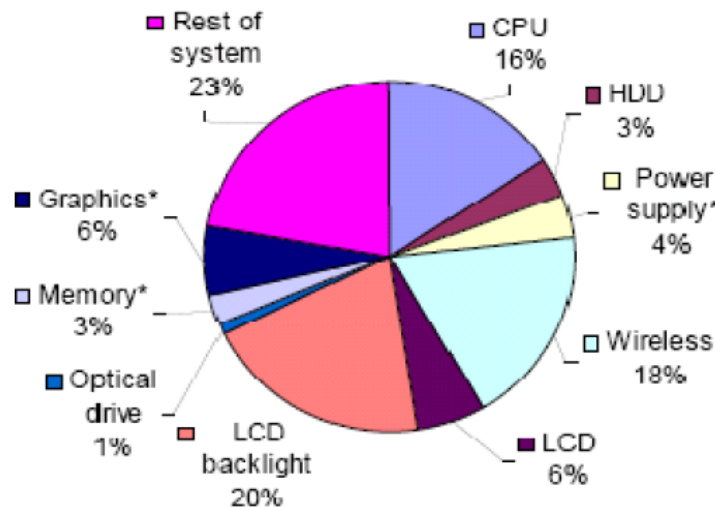

Somavat, Pavel, Shraddha Jadhav, and Vinod Namboodiri.  
"Accounting for the energy consumption of personal Computing including portable devices." in *Proceedings of the 1st ACM International Conference on Energy-Efficient Computing and Networking*, 2010.





- Network-related energy consumption has two components
  - Computing: in network data processing, data fusion and aggregation, protocol operations;
  - Communications: Wireless transceiver consumes energy either to transmit/receive data and control packets, or when it is idle, ready to receive.
- Trade-off between computation and communication
  - There is an inherent computing vs. communication trade-off:
    - ✓ Where should the 'intelligence' of the system be placed? Which data should be processed in network (→higher energy consumption due to computing in nodes which can be energy constrained, but →more compact data transmitted, thus lower energy consumption due to communication) and which data should instead be transmitted to "higher end" devices or computing systems for processing?(e.g., to the base station, to the sink, or which tasks should be offloaded to the cloud)
    - ✓ Not a one fit all answer.
  - Energy-efficient communication protocols can add overhead and computational complexity. Such overhead must be accounted for in the evaluation.

The objective of the energy efficient communication techniques is to optimize these trade-offs, and the trade-offs amongs different E2E performance metrics (not just energy consumption but also throughput, latency).



- Network-related energy consumption has two components
  - Computing: in network data processing, data fusion and aggregation, protocol operations;
  - Communication: energy either to transmit/receive, ready to receive.

• Trade-off between

- Energy-efficient communication
- There is an inherent trade-off between energy consumption and computational complexity.
  - ✓ Where should the processing be done (→higher energy consumption for compact data transmission instead be transmitted to the station, to the server)
  - ✓ Not a one fit all solution

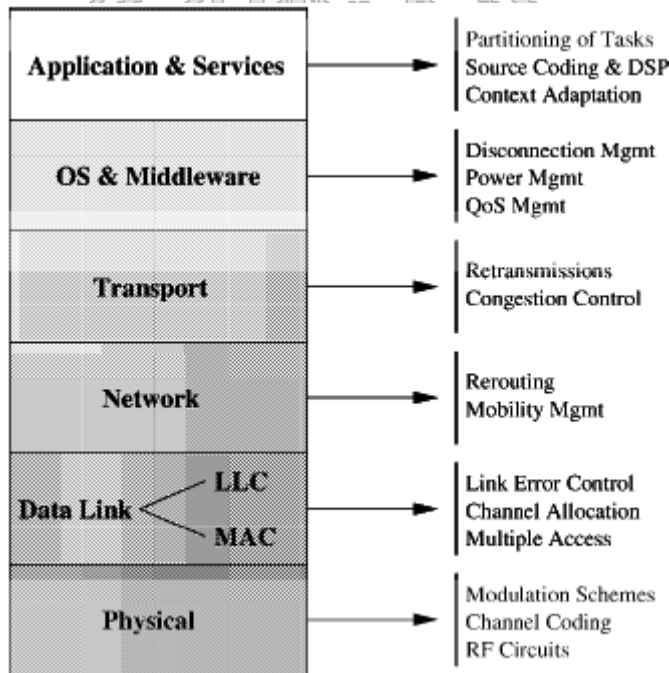

energy either to transmit/receive, ready to receive.

communication

and computational complexity.

Where should the processing be done (→higher energy consumption for compact data transmission instead be transmitted to the station, to the server)

The objective of the energy-efficient communication is to optimize these trade-offs, and the trade-offs amongs different L2E performance metrics (not just energy consumption but also throughput, latency).

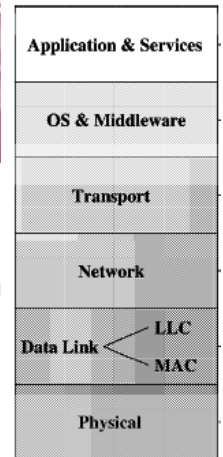

- General guidelines

- PHY:



- ✓ Power consumption is a function of the energy needed to activate the transceiver circuitry and of the emitted power → we can significantly decrease overall energy consumption in case of long range communication by applying power control (**Objective: minimizing transmission energy**)



- ✓ Wireless technologies can dynamically change the modulation scheme used over time. Use of high data rate modulations reduce the time needed to transmit packets, thus the associated transmission energy consumption (**Objective: minimizing transmission energy**)



- ✓ HW-dependent optimization and selection of HW: due to design choices standard compliant transceivers can have quite different performance in terms of energy consumption, BER and PER (Bit and Packet Error Rates). **HW selection can thus significantly impact the overall system energy consumption.**



- ✓ Promiscuous mode: several protocols proposed for ad hoc network routing exploit the idea of operating the wireless interface card in promiscuous mode (→received packets are passed to higher layers and processed even if not addressed to the node) in order to gather information over the wireless broadcast channel which can be used to optimize the protocol operations.

  - ✓ Operating the wireless interface card in promiscuous mode forces the interface card to stay in idle (instead of low power modes) for long periods of time, and leads to significant energy consumption due to processing of packets. Therefore, its use typically is a killer in terms of overall energy consumption.



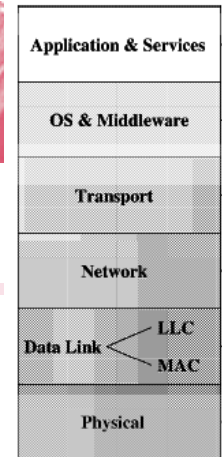

- General guidelines

- PHY:



- ✓ Power consumption is a function of the energy needed to activate the transceiver circuitry and of the emitted power → we can significantly decrease overall energy consumption in case of long range communication by applying power control (**Objective: minimizing transmission energy**)



- ✓ Wireless technologies can dynamically change the modulation scheme used over time. Use of high data rate modulations reduce the time needed to transmit packets, thus the associated transmission energy consumption (**Objective: minimizing transmission energy**)



- ✓ HW-dependent optimization and selection of HW: due to design choices standard compliant transceivers can have quite different performance in terms of energy consumption, BER and PER (Bit and Packet Error Rates). **HW selection can thus significantly impact the overall system energy consumption.**



- ✓ Wireless transceiver should instead be switched to a low power 'sleep state' (where it cannot receive or transmit packets but the energy consumption is orders of magnitude lower) whenever a packet not addressed to the node or whenever information exchanged during a handshake make the node aware that the channel will be busy for the next future for transmitting packets not addressed to it
    - ✓ The transceiver should switch to low power mode for the whole time interval when it knows it will not be involved in communications.
      - This is also why destination address is the first field of the header
      - This is also why NAV field is part of RTS/CTS handshake in IEEE 802.11

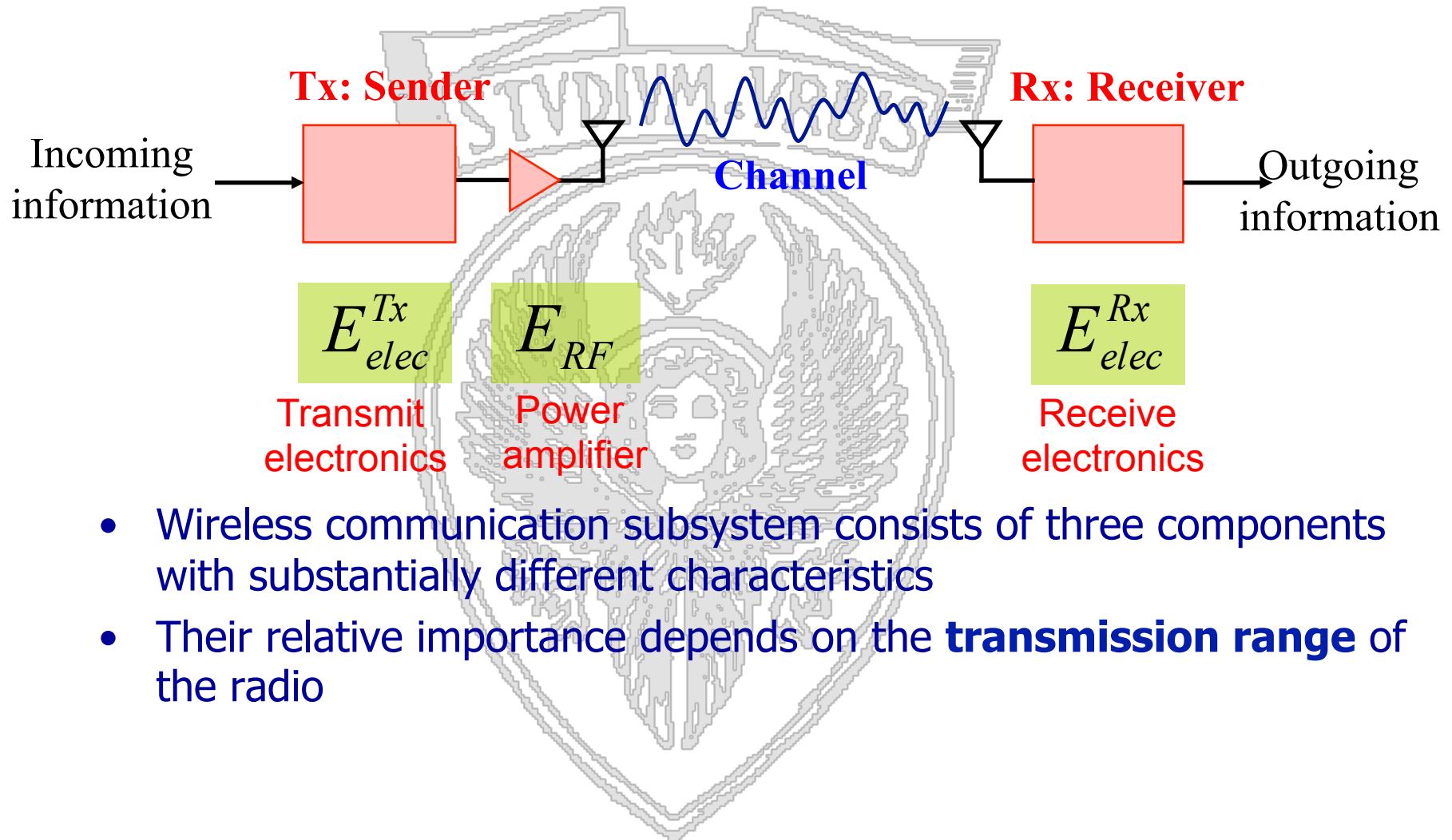

- Wireless communication subsystem consists of three components with substantially different characteristics
- Their relative importance depends on the **transmission range** of the radio





Application & Services
OS & Middleware
Transport
Network
Data Link <span style="display: inline-block; vertical-align: middle; margin-left: 10px;">LLC MAC</span>
Physical

- General guidelines

- MAC

- ✓ **Awake/asleep schedule:** Nodes alternate between

- high energy consuming states (awake:transmit/receive/idle) in which the transceiver is ON and packets can be transmitted/received AND
- states in which the transceiver is OFF, packets cannot be received or transmitted but the energy consumption is much lower.
- Duty cycle= $T_{ON}/(T_{ON}+T_{OFF})$
- Two possible classes of protocols:
  - » Synchronous:
    - nodes exchange information to coordinate on when to wake up;
    - periodic control message exchange ensures they know when their neighbors will wake up;
    - a packet is transmitted to a neighbor when it is ON.
  - » Asynchronous:
    - Awake/asleep schedule of neighbors is unknown;
    - No control overhead is needed to keep information updated;
    - To ensure reliable communications a sequence of packets must be sent until the destination node wakes up and answers (overhead when a packet has to be sent)
    - OR nodes must follow a cross-layering approach selecting one neighbors among the awake neighbors as relay.

- ✓ Nodes not involved in communication should go to sleep till current information exchange completes (**Objective: avoid energy waste**).
- ✓ Nodes should minimize collisions (**Objective: avoid energy waste**)
- ✓ Header compression: By transmitting less bits the transceiver is ON for less time (**Objective: reducing transmission energy**)
- ✓ Limit control information exchanged, aggregate redundant information (**Objective: reducing transmission energy**)

Tends to increase latency





Application & Services
OS & Middleware
Transport
Network
Data Link <span style="display: inline-block; vertical-align: middle; margin-left: 10px;">LLC MAC</span>
Physical

- General guidelines

- MAC

- ✓ **Awake/asleep schedule:** Nodes alternate between

- high energy consuming states (awake:transmit/receive/idle) in which the transceiver is ON and packets can be transmitted/received AND
      - states in which the transceiver is OFF, packets cannot be received or transmitted but the energy consumption is much lower.

- Duty cycle =  $T_{ON} / (T_{ON} + T_{OFF})$

- Two possible classes of protocols:

- » Synchronous:

- nodes exchange information to coordinate on when to wake up;
          - periodic control message exchange ensures they know when their neighbors will wake up;
          - a packet is transmitted to a neighbor when it is ON.

- » Asynchronous:

- Awake/asleep schedule of neighbors is unknown;
          - No control overhead is needed to keep information updated;
          - To ensure reliable communications a sequence of packets must be sent until the destination node wakes up and answers (overhead when a packet has to be sent)
          - OR nodes must follow a cross-layering approach selecting one neighbors among the awake neighbors as relay.

- ✓ Nodes not involved in communication should go to sleep till current information exchange completes (**Objective: avoid energy waste**).

- ✓ Nodes should minimize collisions (**Objective: avoid energy waste**)

- ✓ Header compression: By transmitting less bits the transceiver is ON for less time (**Objective: reducing transmission energy**)

- ✓ Limit control information exchanged, aggregate redundant information (**Objective: reducing transmission energy**)

Tends to  
increase  
latency





Application & Services
OS & Middleware
Transport
Network
Data Link <span style="display: inline-block; vertical-align: middle; margin-left: 10px;">LLC MAC</span>
Physical

- General guidelines

- MAC

- ✓ **Awake/asleep schedule:** Nodes alternate between

- high energy consuming states (awake:transmit/receive/idle) in which the transceiver is ON and packets can be transmitted/received AND
- states in which the transceiver is OFF, packets cannot be received or transmitted but the energy consumption is much lower.

- Duty cycle =  $T_{ON} / (T_{ON} + T_{OFF})$

- Two possible classes of protocols:

- » Synchronous:

- nodes exchange information to coordinate on when to wake up;
    - periodic control message exchange ensures they know when their neighbors will wake up;
    - a packet is transmitted to a neighbor when it is ON.

- » Asynchronous:

- Awake/asleep schedule of neighbors is unknown;
    - No control overhead is needed to keep information updated;
    - To ensure reliable communications a sequence of packets must be sent until the destination node wakes up and answers (overhead when a packet has to be sent)
    - OR nodes must follow a cross-layering approach selecting one neighbors among the awake neighbors as relay.

- ✓ Nodes not involved in communication should go to sleep till current information exchange completes (**Objective: avoid energy waste**).

- ✓ Nodes should minimize collisions (**Objective: avoid energy waste**)

- ✓ Header compression: By transmitting less bits the transceiver is ON for less time (**Objective: reducing transmission energy**)

Tends to increase latency



Energy consumption due to reception is typically >> than that for transmission, as it is not possible to predict when a packet will have to be received: ← wake-up radio





- Transceiver can be in one of the following states

**tx**

*Awake and transmitting*

**rx**

*Awake and receiving*

**idle**

*Awake, neither transmitting nor receiving*

**asleep**

*Asleep: the transceiver is not operational but energy consumption is low. There can be several asleep states with different subsets of the circuitry switched OFF → different time to switch to such states, but also different energy consumption.*

**There is a time and energy consumption associated to the switch which should be accounted for when designing energy efficient protocols**



- Depend on technology, transmission range and phy layer solutions have an impact
- For the same type of device/technology significant changes in the energy consumption have occurred over time
  - As designers are striving to make technology more low power
  - Changes also occurred in the relative weight of different components of energy consumption (which has an impact on design of energy efficient protocols)
- Years: 90'-' 00
  - Message: transmitting costs >> receiving; idle cost costs significantly less, sleep mode 2-3 order of magnitudes lower
  - Examples:
    - ✓ Proxim RangeLAN2 2.4 GHz 1.6 Mbps PCMCIA card: 1.5 W in transmit, 0.75 W in receive, and 0.01 W in standby mode.
    - ✓ Lucent's 15 dBm 2.4 GHz 2 Mbps Wavelan PCMCIA card: 1.82 W in transmit mode, 1.80 W in receive mode, and 0.18 W in standby mode.





- Depend on technology, transmission range and phy layer solutions have an impact
- For the same type of device/technology significant changes in the energy consumption have occurred over time
  - As designers are striving to make technology more low power
  - Changes also occurred in the relative weight of different components of energy consumption (which has an impact on design of energy efficient protocols)
- Years: 90'-'00
  - Message: transmitting costs >> receiving; idle cost costs significantly less, sleep mode 2-3 order of magnitudes lower
  - Examples:
    - ✓ Proxim Rangel AN2 2.4 GHz 1.6 Mb/s PCMCIA card: 1.5 W in transmit 0.75

Nowadays for many low to medium range radio technologies transmission energy consumption is comparable to reception energy consumption and comparable to that of idle mode



- When transmission range increases the percentage of transmitted energy due to emitted power increases  
(data source: M. Srivastava, beginning of 2001)

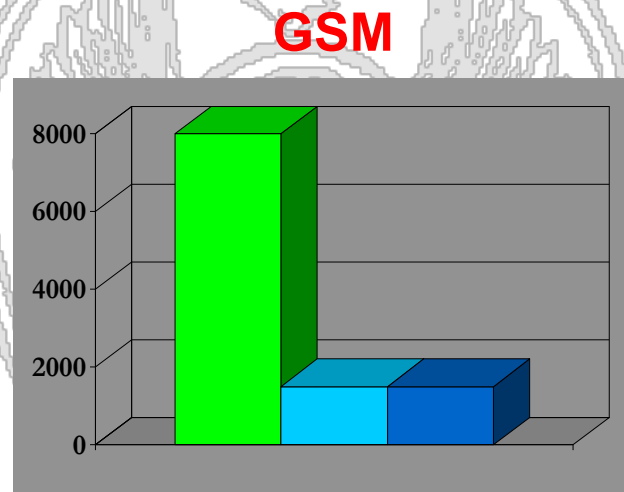

Long range  
communications

$$E_{RF} \quad E_{elec}^{Tx} \quad E_{elec}^{Rx}$$

**~ 1 km**



- TmoteSky, EYES v2.0 platforms

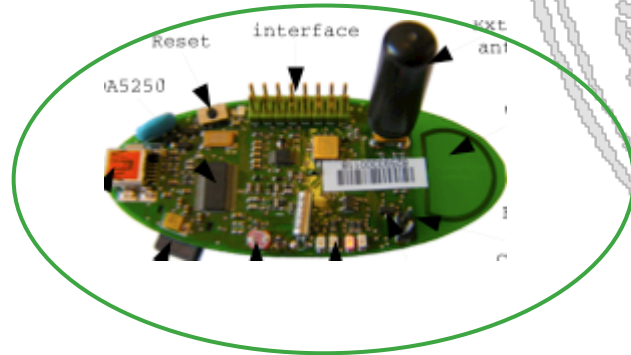

Texas Instruments Mps430 micro-controller,

16-b  
fast  
DCA  
Ligh

**TmoteSky:**

radio chip CC2420 (Zigbee compliant),  
2Ghz direct sequence spread spectrum  
(DSSS) modulation, datarate 250Kbps,  
on board 1 Mb serial EEPROM,

**EyesIFXv2:**

radio chip TDA5250, 868Mhz,  
FSK modulation, datarate 64Kbps,  
on board 512Kb serial EEPROM



## CC2420 Modules

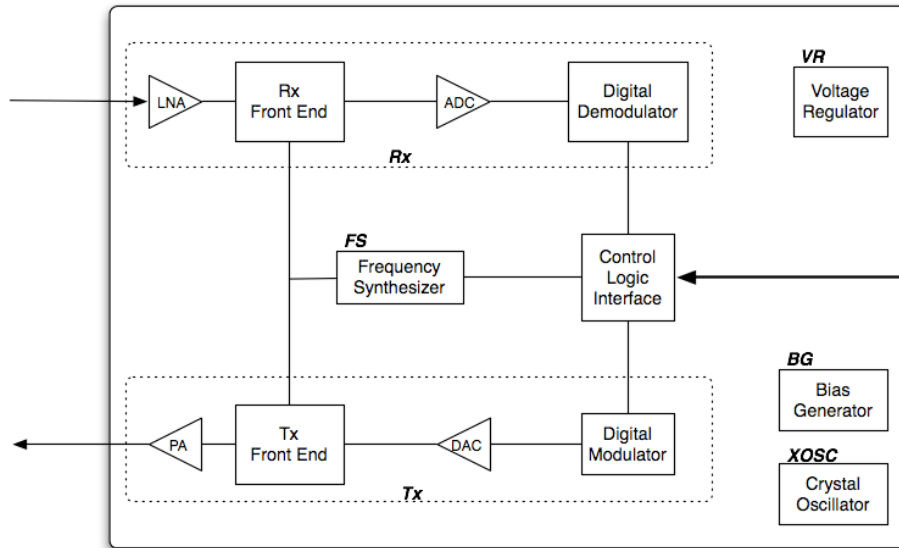

## Transceiver states

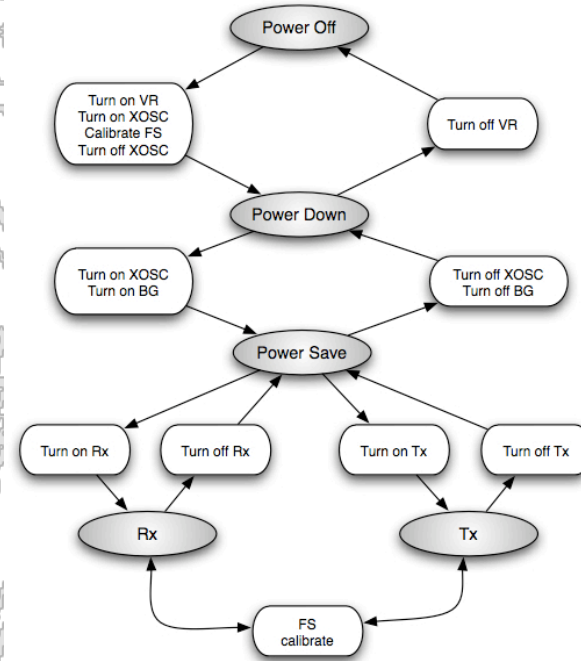

## Energy model

State	Consumption (mA)
Rx	19.7
Tx	17.4
Save	0.45
Down	0.02
Off	0.001

Table 1: Consumption of CC2420 transceiver.

Switch Between (States)	Consumption (mA)	Duration (ms)
Rx/Tx	17.4	0.192
Tx/Rx	19.7	0.192
Tx/Save	17.4	0.192
Rx/Save	19.7	0.192
Save/Down	0.45	0.96
Down/Off	0.02	0.6

Table 2: Switch time of CC2420 transceiver.





Energy model

State	Consumption (mA)
<i>Rx</i>	8.6
<i>Tx</i>	11.2
<i>Stand-by</i>	0.75
<i>Power-down</i>	0.009
<i>Power-off</i>	0

State	Consumption (mA)	Duration (ms)
<i>Power-off/Tx</i>	0.3085	9.1
<i>Power-off/Rx</i>	0.2632	10.2
<i>Tx/Rx</i>	0.0739	2.2
<i>Rx/Tx</i>	0.0369	1.1
<i>Power-down/Tx</i>	0.0025	1.1
<i>Power-down/Rx</i>	0.0568	2.2
<i>Stand-by/Tx</i>	0.0025	1.1
<i>Stand-by/Rx</i>	0.0568	2.2

Transceiver states

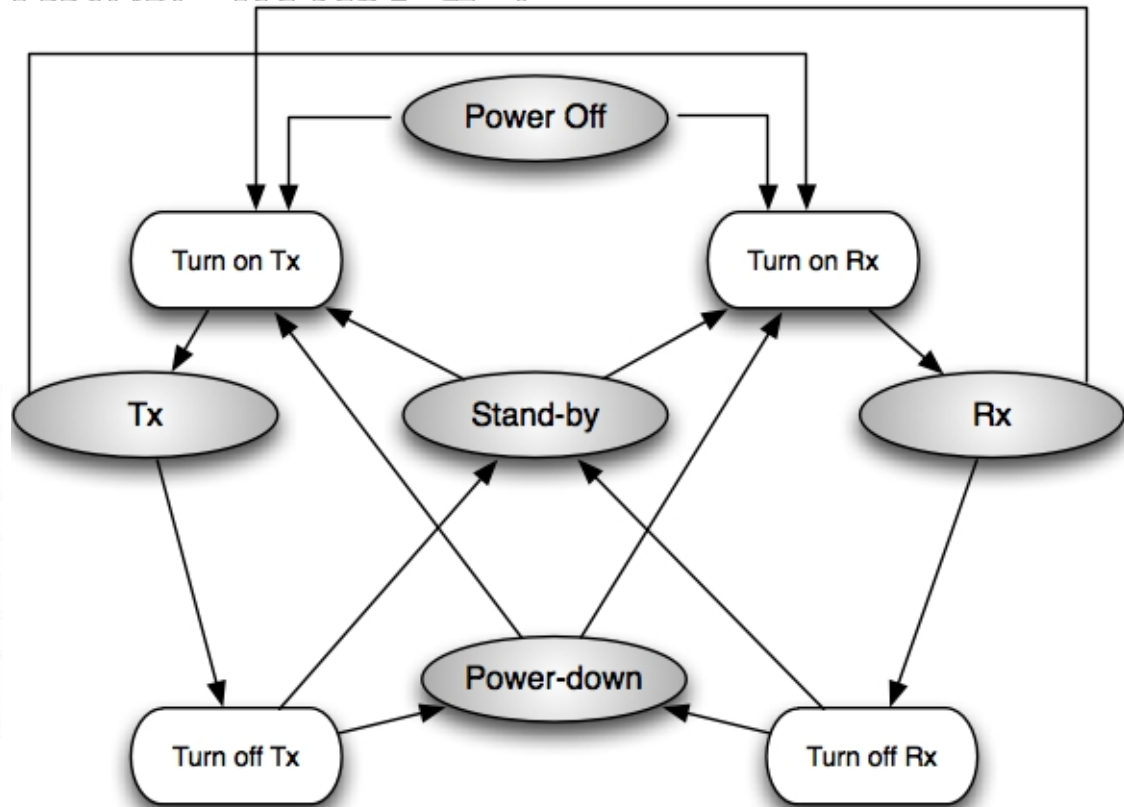



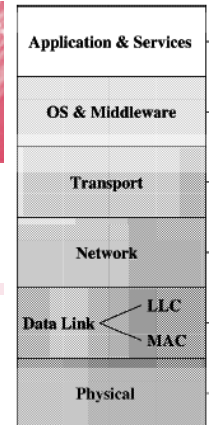

- General guidelines

- Data Link



- ✓ If channel is in a bad (deep fade) state it is convenient to delay transmissions as it is very unlikely packets will be correctly received (**Objective: avoid waste**)



- ✓ Energy efficient ARQ and FEC schemes have been studied to optimize energy consumption while ensuring reliable and timely communication (overhead vs. number of retransmissions trade-off; adaptive solutions depending on load, channel, application requirements).

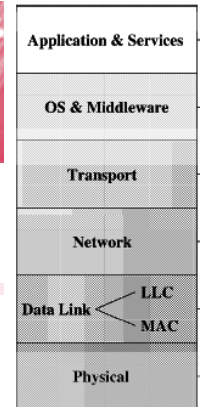

- General guidelines

- Routing

- ↑ ✓ Depending on the scenario it can be more energy efficient to transmit over a higher number of shorter links or minimize the number of hops (**can you tell me when one option is better than the other? Suggestion: Long range vs. short range communication**)
    - ↑ ✓ Minimize the overhead associated to route discovery and maintenance
    - ↑ ✓ Load balancing of the energy consumption among nodes to increase the network lifetime;
    - ↑ ✓ Energy aware routing solutions which account for residual energy (and expected future availability of energy in case harvesting is an option) when selecting the best next hop relay.
    - ↑ ✓ Link quality aware relay selection to avoid retransmissions.
    - ↑ ✓ Relay selection which favors data fusion/aggregation.
    - ↑ ✓ All the above combined ← cross layer solutions.



- In the last few years there has been a change of devices used to access the Internet
  - From PC to smartphone
  - Novel Phy layer and more advanced transceiver features
  - How has the energy model been affected by changes in the device technology?
  - Can we still make the same assumptions or are there additional components to account for?

In the following the outcomes of:

N. Balasubramanian, A. Balasubramanian, A. Venkataramani "Energy consumption in mobile phones: A Measurement Study and Implications for Network Applications", ACM IMC 2009. Observation: Workload impacts energy consumption of typical devices (cellular-GSM/3G; WiFi)

A. Garcia Saavedra, P. Serrano, A. Banchs, G. Bianchi "Energy Consumption Anatomy of 802.11 Devices and Its Implication on Modeling and Design" in Proceedings of Co-NEXT 2012 (on WiFi)



- Implementations and choices made for implementing standards make the difference:
  - N. Balasubramanian, A. Balasubramanian, A. Venkataramani “Energy consumption in mobile phones: A Measurement Study and Implications for Network Applications”, ACM IMC 2009. Observation: Workload impacts energy consumption of typical devices (cellular-GSM/3G; WiFi)
    - ✓ In 3G, a large fraction (nearly 60%) of the energy, referred to as the *tail energy*, is wasted in high-power states after the completion of a typical transfer.

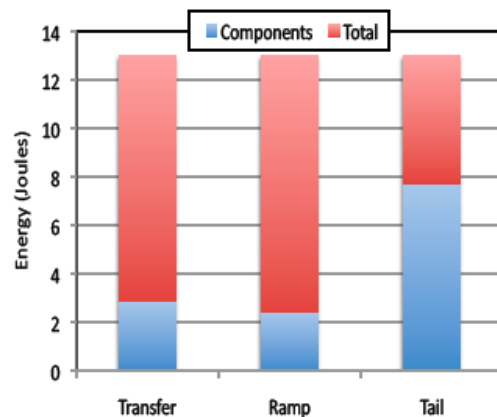

Typical 3G transfer  
HTTP request issued to a remote server  
50KB download  
Nokia N95





- Implementations and choices made for implementing standards

- N. Balas  
“Energy and Imp  
Observa  
devices

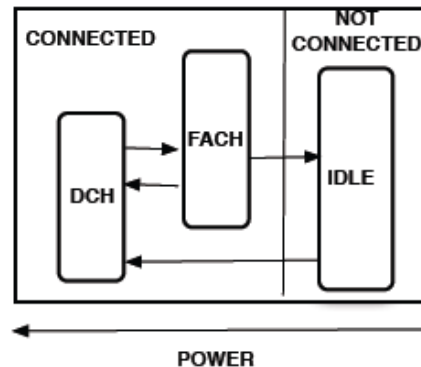

kataramani  
ement Study  
IMC 2009.  
ion of typical

- ✓ In 3G, a large fraction (nearly 60%) of the energy, referred to as the *tail energy*, is wasted in high-power states after the completion of a typical transfer.
  - Switching back from an active state is handled by means of inactivity timers often set to a few seconds.
- ✓ Tail and ramp energies (more limited) are constants that amortize over larger transfer sizes or frequent successive transfers.





- Implementations and choices made for implementing standards make the difference:
  - N. Balasubramanian, A. Balasubramanian, A. Venkataramani “Energy consumption in mobile phones: A Measurement Study and Implications for Network Applications”, ACM IMC 2009. Observation: Workload impacts energy consumption of typical devices (cellular-GSM/3G; WiFi)
    - ✓ In 3G, a large fraction (nearly 60%) of the energy, referred to as the *tail energy*, is wasted in high-power states after the completion of a typical transfer.
      - Switching back from an active state is handled by means of inactivity timers often set to a few seconds.
    - ✓ Tail and ramp energies (more limited) are constants that amortize over larger transfer sizes or frequent successive transfers.



# Device and standard- dependent optimizations

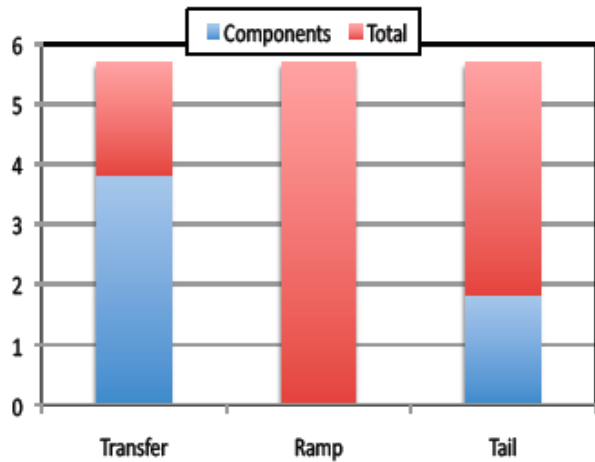

GSM shows a different trend  
Lower power  
More significant transmission energy  
Less significant (even if present) tail energy effect

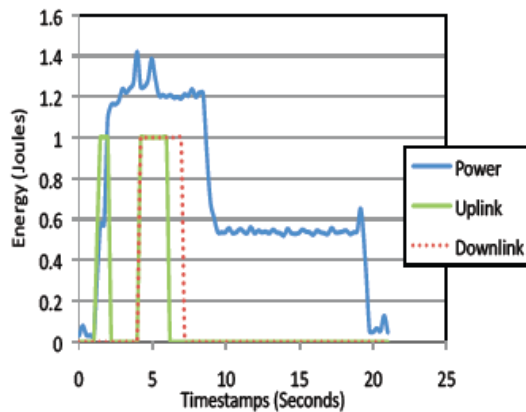

(a) 3G: Power Profile - 50K

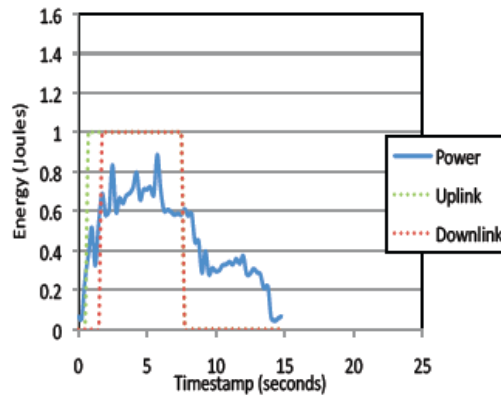

(b) GSM: Power Profile - 50K

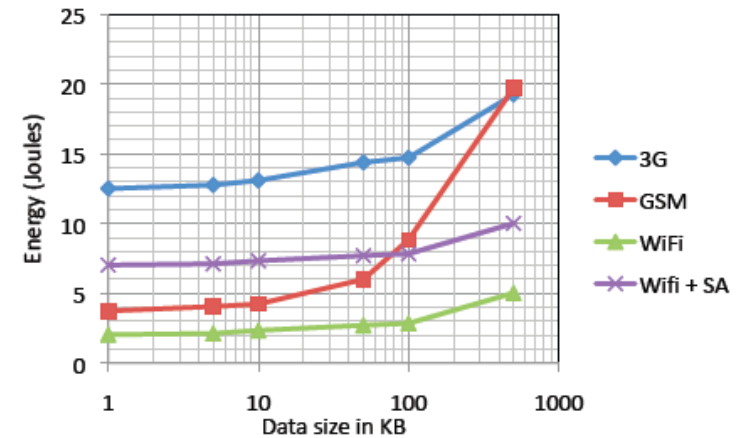



- Three ideas:
  - Combine use of 3G and WiFi (with prediction of WiFi availability)
  - For delay tolerant applications (news, emails) delay transfer if tolerable delay so to transfer batches
  - For web surfing applications design of energy-optimized prefetching techniques

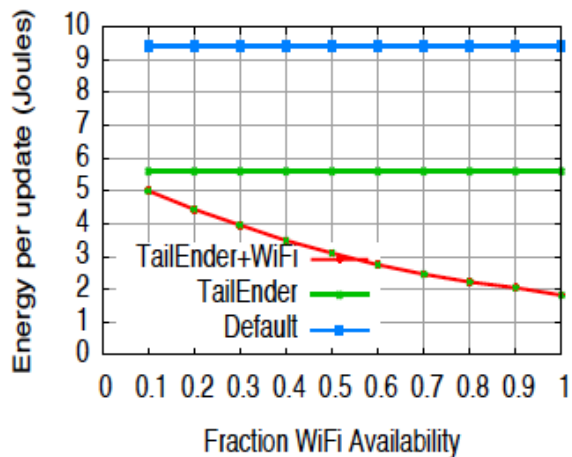

Figure 22: News feed. Average energy improvement when switching between WiFi and 3G networks.

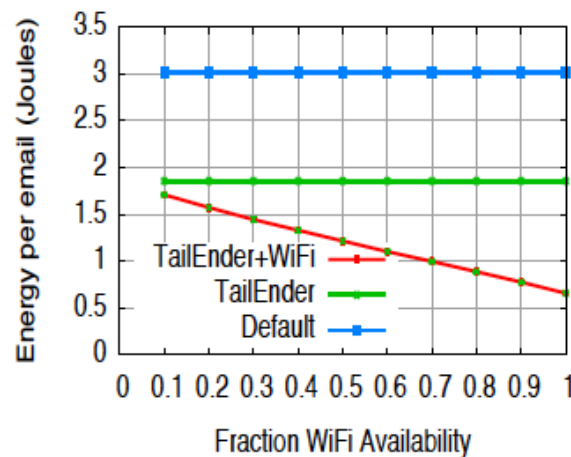

Figure 23: E-mail. Average energy improvement when switching between WiFi and 3G networks.

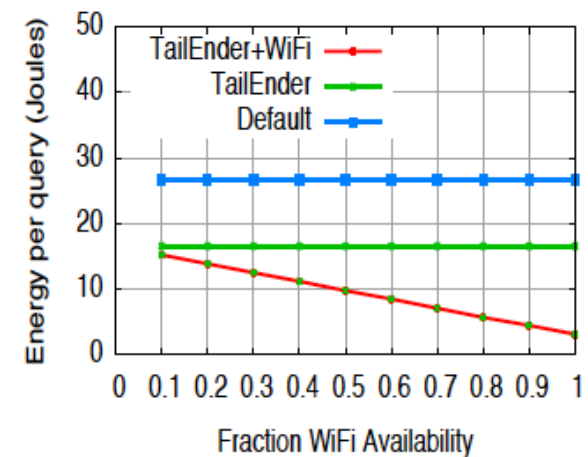

Figure 24: Web Search. Average energy improvement when switching between WiFi and 3G networks.



- Experiments and measurements on multiple commercial devices
  - Soekris net 4826-48 + Atheros 802.11a/b/g Mini-PCI card, configured to use the 802.11a PHY
  - Alix2d2 + Broadcom BCM4319 802.11b/g Mini-PCI card
  - Linksys WRT54GL + Broadcom BCM4320 802.11b/g Mini-PCI card
- Checking no interference (sniffers)
- Measuring energy consumption with high accuracy power meters
- Controlled traffic generation (mgen generates UDP packets)





- Baseline energy consumption has been measured

Table 2: Soekris Baseline consumption profile

Config.	Description	Cons. (W)
w/o card	no NIC connected	$2.29 \pm 2.2\%$
WiFi off	NIC connected driver not loaded	$2.58 \pm 2.0\%$ (+0.29)
Idle ( $\rho_{id}$ )	NIC activated+associated to AP no RX/TX besides beacons	$3.56 \pm 1.7\%$ (+0.98)

- Energy consumption of transmitting one packet without ACKs has been studied
- Impact on energy consumption of varying transmission power, packet length, type of modulation has been quantitatively studied



- Experimental results: Total power consumed by (unacknowledged) transmissions vs. airtime percentage

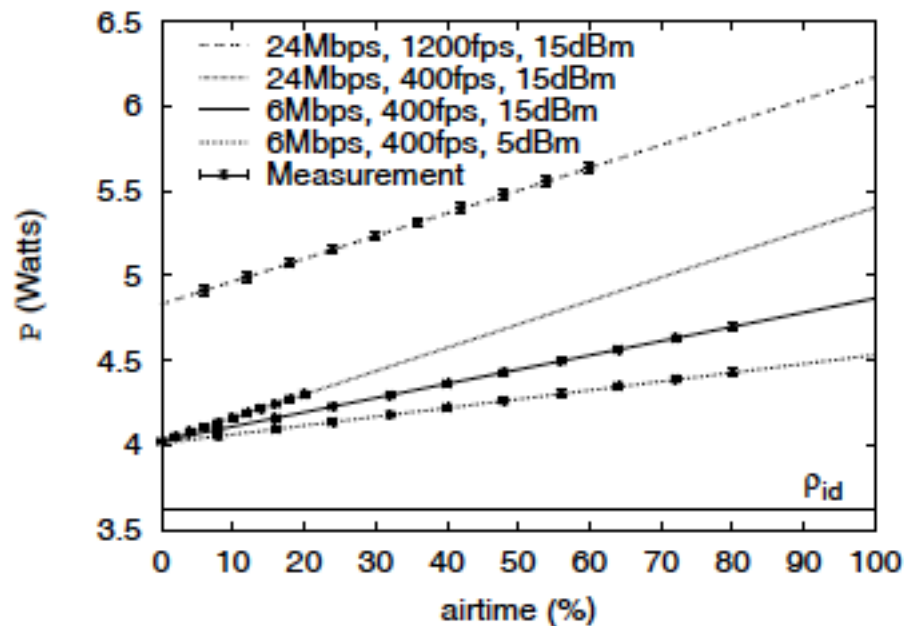

(a) Soekris

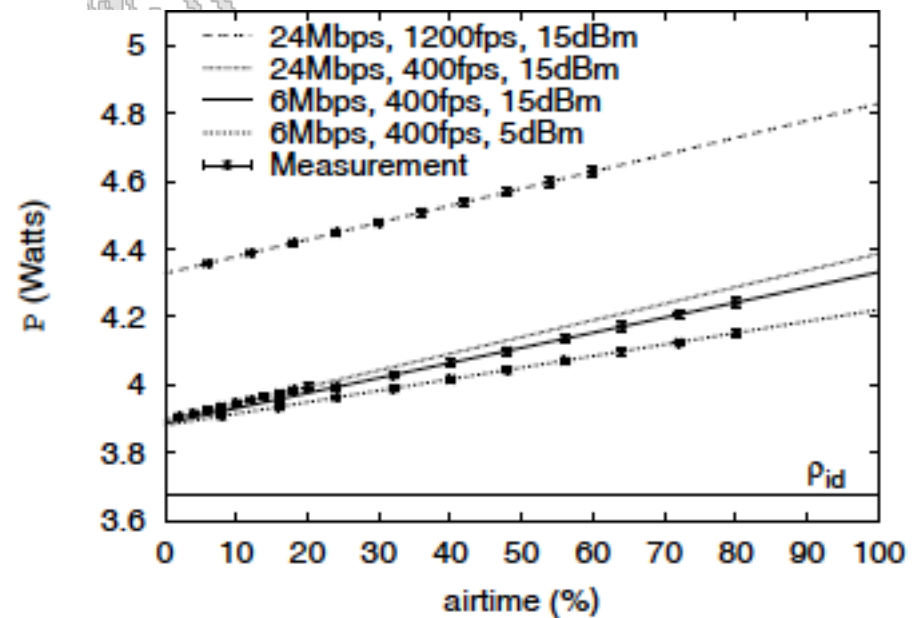

(b) Alix



- Experimental results: Total power consumed by (unacknowledged) transmissions vs. airtime percentage

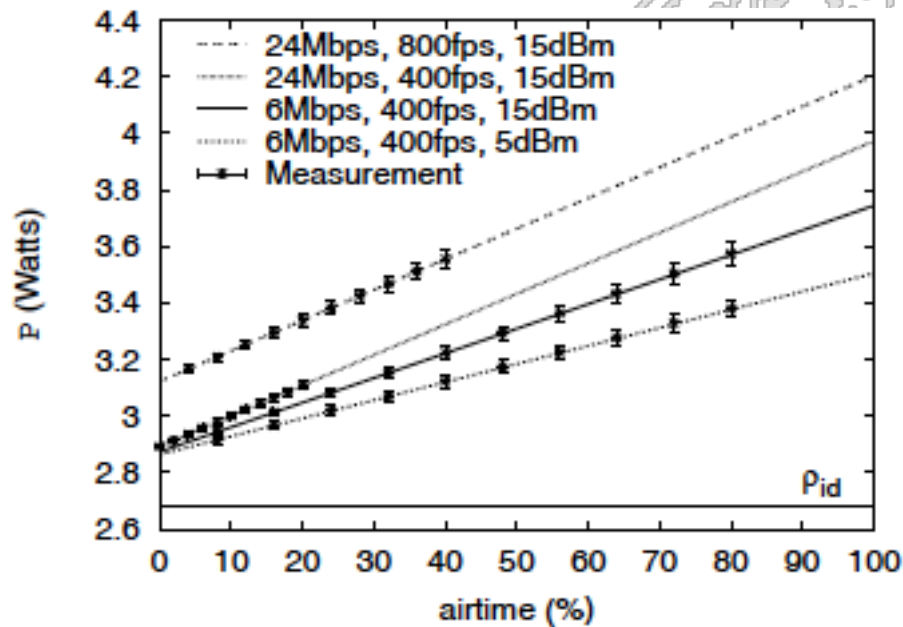

(c) Linksys

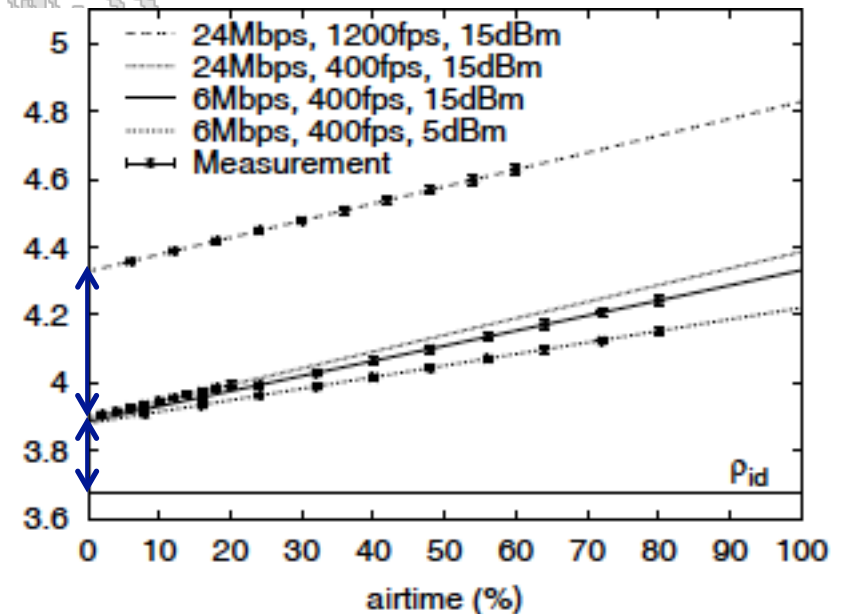

(b) Alix



- Experimental results: Relationship between cross factor and traffic intensity

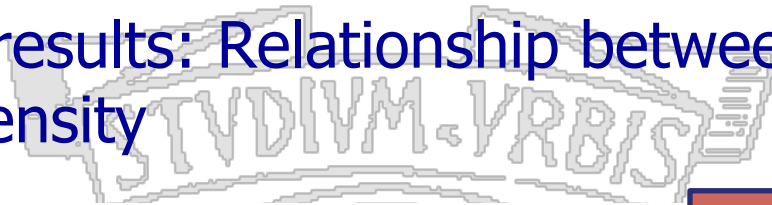

New energy model

$$P = \rho_{id} + P_{tx} + P_{xg}(\lambda_g)$$

$\rho_{id}$  is the platform specific baseline power consumption

$P_{tx}$  is the power consumption

Associated to transmission

(depends on airtime, tx power

Modulation)

$P_{xg}(\lambda_g)$  is the new cross factor

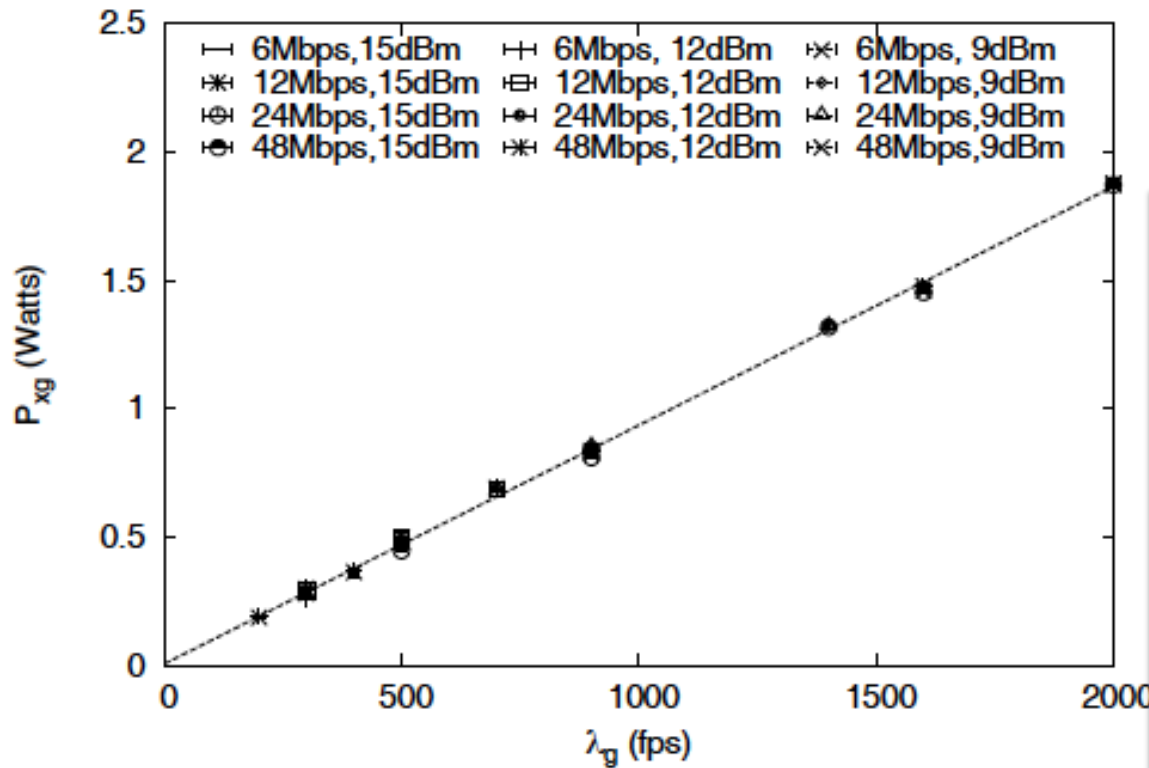
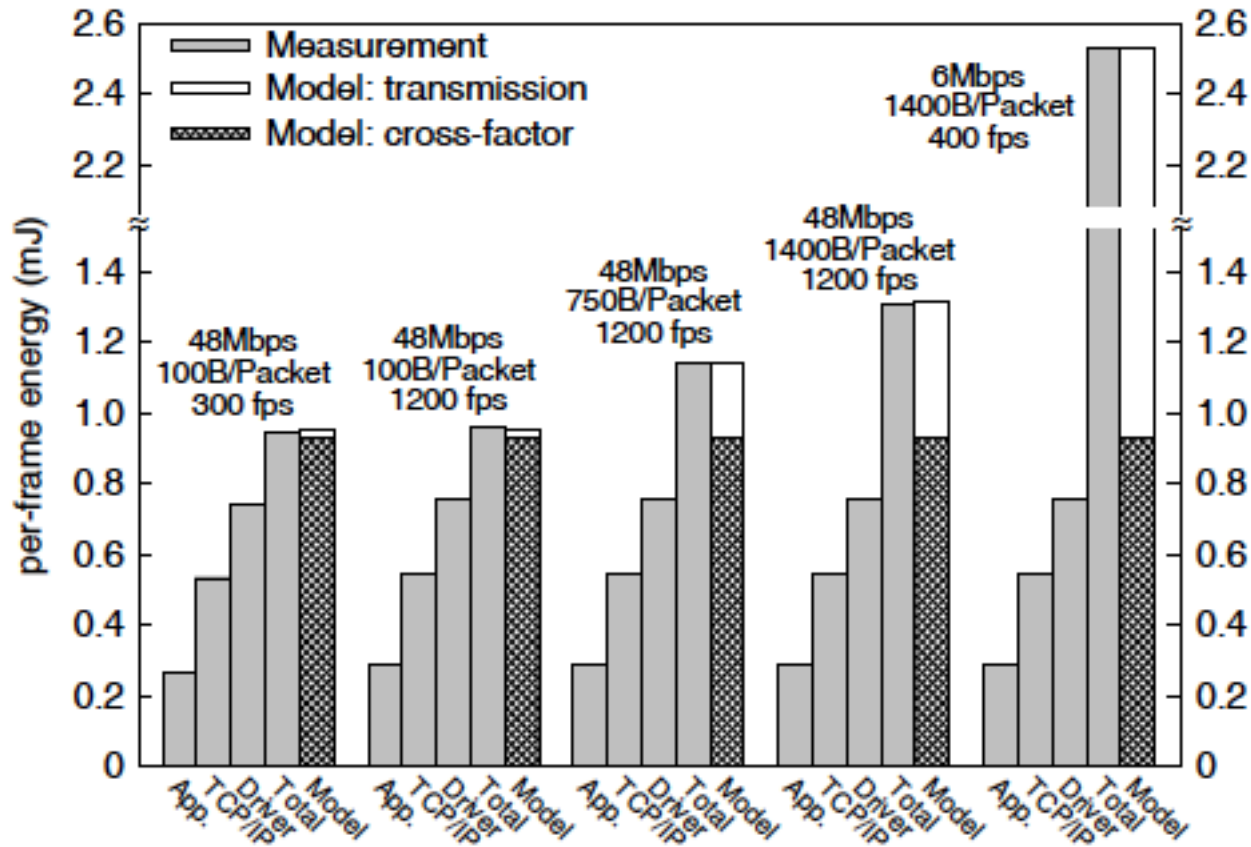

Figure 2: Relation between  $P_{xg}(\lambda_g)$  and  $\lambda_g$ .





New approaches are proposed for

- Packet relay selection
- Data compression
- Data transmission (back to back)
- Stack implementation

Figure 4: Per-frame energy cost in transmission.